

# CME

## UF Intelligent Keyboard Controller User's Manual

---

Model: UF50/60/70/80 Classic  
Read "Precautions" on page 4 before use

### CLASSIC

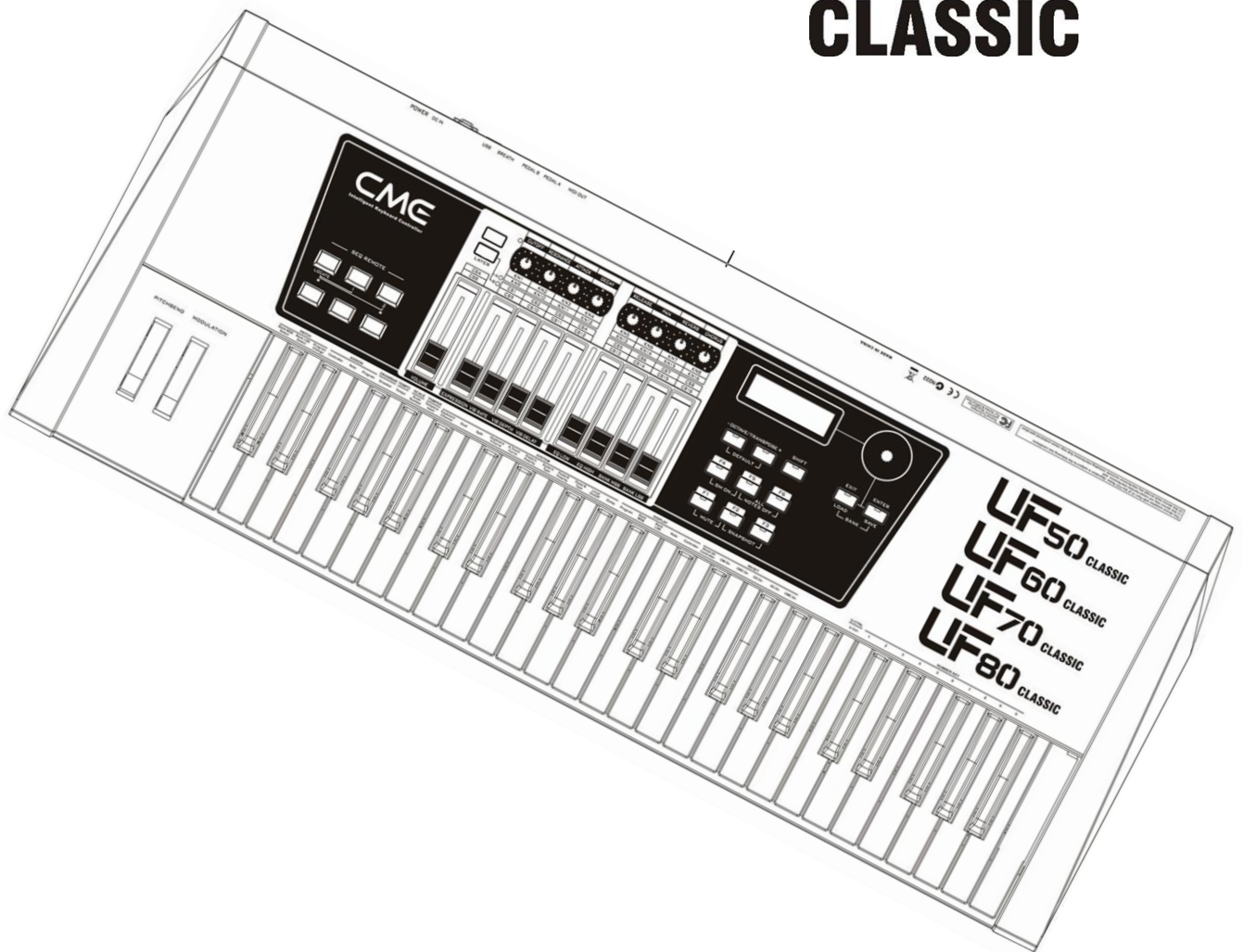

Please read this manual carefully before use.  
Please keep this manual for reference.

**Thank you for choosing CME UF50/60/70/80 Classic Intelligent  
Keyboard Controller**

**Please keep all the important information here**

Attach your invoice or receipt here

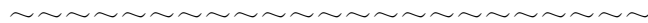

**for reference**

Purchase date	Serial (on the back of the keyboard)
Dealer's name and addr.	
Dealer's tel.	

**Warning:**

- Improper connection may cause damage to the device.

**Copyright**

- Copyright of the manual belongs to Central Music Co. Anyone must get a written permission from Central Music Co. before copying any part of the manual to any kind of media.

© Central Music Co. 2009

---

**Package list**

Please check all the items in the product package:

- USB MIDI Master keyboard 1 pcs
- USB Cable 1 pcs
- User's Manual 1 pcs

## Special Message Section

This product utilizes batteries or an external power supply (adapter). Do NOT connect this product to any power supply or adapter other than one described in the manual, on the product, or specifically recommended by CME.

**WARNING:** Do not place this product in a position where anyone could walk on, trip over, or roll anything over power or connecting cords of any kind. The use of an extension cord is not recommended! If you must use an extension cord, make sure that the cord has the ability to handle maximum current needed by this product. Please consult a local electrician when possible.

This product should be used only with the components supplied or recommended by CME. When used with any components, please observe all safety markings and instructions that accompany the accessory product.

### **SPECIFICATIONS SUBJECT TO CHANGE:**

The information contained in this manual is believed to be correct at the time of printing. However, CME reserves the right to change or modify any of the specifications without notice or obligation to update existing units.

This product, either alone or in combination with an amplifier and headphones or speaker(s), may be capable of producing sound levels that could cause permanent hearing loss. Do NOT operate for long periods of time at a high volume level or at a level that is uncomfortable. If you experience any hearing loss or ringing in the ears, you should consult an audiologist.

**IMPORTANT:** The louder the sound, the shorter the time period before damage occurs.

Some CME products may have stands and/or accessory mounting fixtures that are either supplied with the product or as optional accessories. Some of these items are designed to be dealer assembled or installed. Please make sure that stands are stable and any optional fixtures (where applicable) are well secured BEFORE using.

Stands supplied by CME are designed for the respect products only. No other uses are recommended.

### **NOTICE:**

Service charges incurred due to a lack of knowledge relating to how a function or effect works (when the unit is operating as designed) are not covered by the manufacturer's warranty, and are therefore the owners responsibility. Please study this manual carefully and consult your dealer before requesting service.

### **ENVIRONMENTAL ISSUES:**

CME strives to produce products that are both user safe and environmentally friendly. We sincerely believe that our products and the production methods used to produce them, meet these goals. In keeping with both the letter and the spirit of the law, we want you to be aware of the following:

#### **Battery Notice:**

This product MAY contain a small non-rechargeable battery which (if applicable) is soldered in place. The average life span of this type of battery is approximately five years. When replacement becomes necessary, contact a qualified service representative to perform the replacement.

This product may also use "household" type batteries. Some of these may be rechargeable. Make sure that the battery being charged is a rechargeable type and that the charger is intended for the battery being charged.

When installing batteries, do not mix batteries with new, or with batteries of different type. Batteries MUST be installed correctly. Mismatches of incorrect installation may result in overheating and battery case rupture.

#### **Warning:**

Do not attempt to disassemble, or incinerate any battery. Keep all batteries away from children. Dispose of used batteries promptly and as regulated by the laws in your area. Note: Check with any retailer of household type batteries in your area for battery disposal information.

#### **Disposal Notice:**

Should this product become damaged beyond repair, or for some reason its useful life is considered to be at an end, please observe all local, state, and federal regulations that relate to the disposal of products that contain lead, batteries, plastics, etc. If your dealer is unable to assist you, please contact CME directly.

## **FCC INFORMATION (U.S.A)**

### **1. IMPORTANT NOTICE: DO NOT MODIFY THIS UNIT!**

This product, when installed as indicated in the instructions contained in this manual, meets FCC requirements. Modifications not expressly approved by CME may void your authority, granted by the FCC, to use the product.

### **2. IMPORTANT:** When connecting this product to accessories and/or another product use only high quality shielded cables. Cable(s) supplied with this product **MUST** be used. Follow all installation instructions. Failure to follow instructions could void your FCC authorization to use this product in the USA.

### **3. NOTE:** This product has been tested and found to comply with the limits for a Class B Digital device, pursuant to Part 15 of the FCC Rules. These limits are designed to provide reasonable protection against harmful interference in a residential environment. This equipment generates, uses and can radiate radio frequency energy and, if not installed and used according to the instructions found in the users manual, may cause interference harmful to the operation of other electronic devices. Compliance with FCC regulations does not guarantee that interference will not occur in all installations. If this product is found to be the source of interference, which can be determined by turning the unit "OFF" and "ON", please try to eliminate the problems by using one of the following measures:

Relocate either this product or the device that is being affected by the interference.

Utilize power outlets that are on different branch (circuit breaker or fuse) circuits or install AC line filter(s).

In the case of radio or TV interference, relocate/reorient the antenna. If the antenna lead-in is 300 ohm ribbon lead, change the lead-in to co-axial type cable.

If these corrective measures do not produce satisfactory results, please contact the local retailer authorized to distribute this type of product. If you cannot locate the appropriate retailer, please contact CME.

The above statements apply **ONLY** to those products distributed in the USA.

## PRECAUTIONS

### IMPORTANT

Always follow the basic precautions listed below to avoid the possibility of serious injury or even death from electrical shock, damage, fire or other hazards. These precautions include, but are not limited to, the follows:

1. Read and understand all the instructions.
2. Always follow the instructions on the instrument.
3. Before cleaning the instrument, always remove the electric plug from the outlet as well as the USB cable. When cleaning, use a soft and dry cloth. Do not use gasoline, alcohol, acetone, turps or any other organic solutions; do not use liquid cleaner, spray cleaner or too wet cloth.
4. Do not use the instrument near water or moisture, such as bathtub, washbasin, washing pool in the kitchen or similar places.
5. Do not place the instrument in an unstable position where it might accidentally fall over.
6. Do not jam sinks or holes of the instrument; those sinks or holes are used for air circulation to prevent the instrument from overheating. Do not place the instrument near heat sink or any places with poor air circulation.
7. Do not place anything on the power cord. Make sure the power cord is set on a safe place, so nobody will step on it and no body will trip over it.
8. Do not overload the outlet and the AC cable to avoid fire or electrical shock.
9. Do not insert anything in the instrument, which may cause fire or electrical shock. Do not splash any kind of liquid to the instrument.
10. Do not disassemble the instrument in case of accidental electrical shock.
11. Always take the instrument to a qualified service center in need of repair. You will put yourself in danger if you open or remove the cover, and improper assembly may cause electrical shock in the future use.
12. Unplug all the connectors and take the instrument to a qualified service center if anything in the below listed happens:
  - A. The power cord or connector get damaged or worn out.
  - B. Any liquid get in the instrument.
  - C. The instrument gets rain or water splashed.
  - D. The instrument does not work properly after following all the instructions regarding to the trouble shootings.
  - E. The instrument falls down or gets broken.
  - F. The instrument functions poorly.
13. Do not use the instrument during thunder; otherwise the thunder may cause long-distance electrical shock.
14. Do not use the instrument when there is a gas leak nearby.
15. Switch off the product when inside or near aircraft. The use of RF product in aircraft is illegal. It may be dangerous to the operation of the aircraft
16. Do not use the product on the ground without the permission of the ground crew in the airport.
17. Observe 'Turn off the RF communication device such as Mobile Phone' signs, such as those near stores of fuel, chemicals or explosives
18. The operation of some medical electronic devices, such as hearing aids and pacemakers, may be affected if the product is used next to them. Observe any warning signs and manufacturer's recommendations.
19. Please do not use the product near any precision instrument, which may cause noise or abnormal operation to the instrument.
20. Switch off the product at a refueling point, such as a petrol station, even if you are not refueling your own car.
21. Do not store or carry flammable or explosive materials in the same compartment where a radio transmitter, such as the product, is placed.
22. Electronic vehicle systems, such as anti-lock brakes, speed control and fuel injection

systems are not normally affected by radio transmissions. The manufacturer of such equipment can advise if it is adequately shielded from radio transmissions. If you suspect vehicle problems caused by radio transmissions, consult your dealer and do not switch on the product until it has been checked by qualified approved installers.

### **Efficient Use**

For optimum performance with minimum power consumption, note the following:

- ◆ The product has an internal antenna. Do not cover part of the internal antenna of the product with your hands. This affects communication quality, may cause the product to operate at a higher power level than needed and may shorten communication and standby times.

**Keep this manual in safe place**

## **CAUTION:**

### **Setting up**

Do not connect the instrument during a thunderstorm.

Do not set up the power cord or socket in a damp place, it is specially designed for damp areas.

When the power cord is connected to the AC outlet, do not touch the naked part of the cord or the connector.

Always follow the instructions carefully when setting up the product.

Avoid using any poor quality extending USB cable or too long extending USB cable.

Do not use USB HUB to connect the product.

Make sure the computer USB port has adequate power supply, otherwise the product does not work properly.

## **WARNING:**

- Do not expose the instrument to rain or moisture, avoid fire or electrical shock.

## **Other Precautions:**

- Keep the instrument away from electrical interface sources, such as fluorescent light and electrical motors.
- Keep the instrument away from dust, heat and vibration.
- Do not expose the instrument to sunlight.
- Do not place heavy objects on the instrument; do not place containers with liquid on the instrument.
- Do not touch the connectors with wet hands
- Central Music Co. is not responsible for any damage or data loss caused by improper operation to the instrument.
- All the pictures and the LED display in the manual are used for demonstration; they may be different from the real product.

## **Trade Marks**

CME, UF are CME trade marks. Other brands and names belong to the respective owners.

## **Features**

UF 50/60/70/80 Classic series

- Professional semi-weighted keyboard with aftertouch for UF 50/60/70 Classic
- Professional weighted Hammer Effect Keyboard with aftertouch for UF 80 Classic
- Multi-function expansion slot for firewire expansion, sound module expansion, etc.
- 9 faders
- 11 function buttons
- 8 multi-function knobs
- Various temperaments and scales.
- U-CTRL function by CME, so you can press one key for the software remote control
- USB plug and play
- Firmware upgradable via USB

# Content

1	General View.....	9
1.1	Front Panel.....	9
1.2	Rear Panel.....	11
2	Installation Guide.....	12
2.1	Power Supply.....	12
2.2	Power On Order.....	12
3	Connections.....	13
4	Basic Operation.....	14
5	Turning On.....	16
5.1	Turning On Normally.....	16
5.2	Driver Installation.....	16
5.3	Turning On With Initalizaing.....	16
6	Basic Functions.....	17
6.1	Selecting A Voice Quickly.....	17
6.2	Transpose And Octave.....	17
6.3	Using Knobs And Faders.....	18
6.4	Using SEQ Control Buttons.....	18
6.5	Using Function Shortcut Buttons.....	18
6.6	Pitch Wheel And Modulation Wheel.....	18
6.7	Pedal.....	19
6.8	Breath Controller.....	19
6.9	Aftertouch.....	19
6.10	Bank Selection And Program Change (Patch).....	19
6.10.1	Bank MSB Select.....	19
6.10.2	Bank LSB Select.....	19
6.10.3	Program Change.....	20
6.11	Keyboard Channel.....	20
7	Advanced Functions.....	21
7.1	Dual Mode.....	21
7.2	Split Mode.....	21
7.3	Scale.....	21
7.4	Temperament.....	22
7.5	Drawbar.....	22
7.6	Tempo.....	22
7.7	MIDI Reset Message.....	22
8	Assigning.....	23
8.1	Assigning Controllers.....	23
8.2	Assigning Notes.....	23
8.3	Assigning Program Changes.....	23
9	System Settings.....	24
9.1	Keyboard V.Curve.....	24
9.2	A.Touch V.Curve.....	24
9.3	Pedal A Polarity.....	24
9.4	Pedal A Type.....	25
9.5	Pedal B Polarity.....	25
9.6	Pedal B Type.....	25
9.7	Local On/Off.....	25
9.8	Data Dump.....	25
10	Display.....	26
10.1	Program Display.....	26
10.2	Bank MSB Display.....	26
10.3	Bank LSB Display.....	26
10.4	Note Display.....	26
10.5	Controller Display.....	26



11 U-CTRL mode .....	27
12 Registration Bank Access .....	28
13 Firmware Update .....	28
14 Expansion .....	28
15 Appendix .....	29
15.1 Initial Status .....	29
15.2 Assignable Controllers List.....	31
15.3 GM Voice List .....	35
15.4 Scale List.....	36
15.5 Note List.....	41
15.6 Temperament List.....	41
15.7 Velocity Curve List .....	42
15.8 Aftertouch Curve List .....	43
15.9 MIDI Route .....	44
16 Troubleshooting .....	45
17 Specifications .....	46
18 MIDI Implementation Chart.....	47

# 1 General View

## 1.1 Front Panel

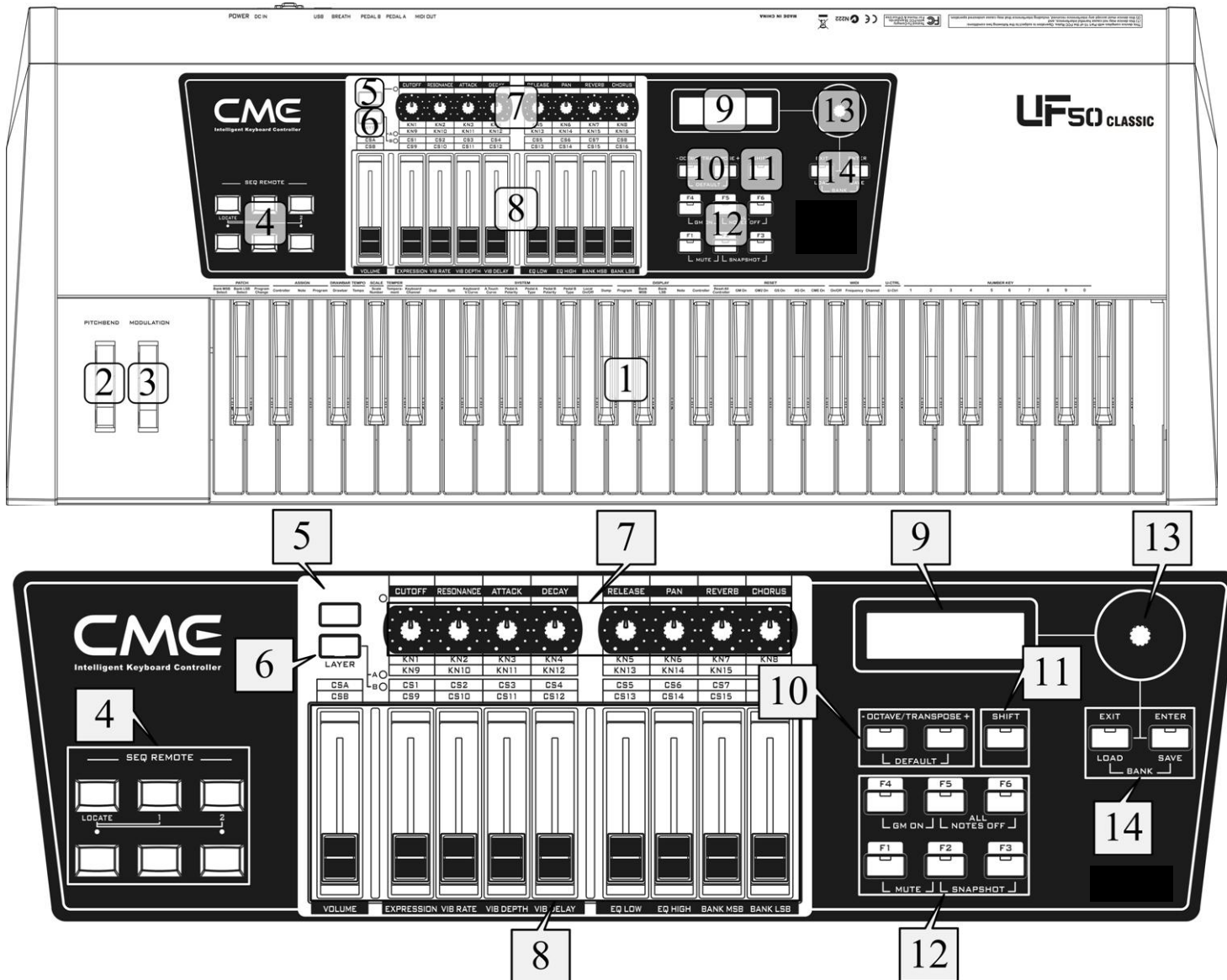

### 1 Keyboard

There are four models for the UF Classic series, comprising UF 50 Classic (49 keys), UF 60 Classic (61 keys), UF 70 Classic (76 keys) and UF 80 Classic (88 keys). All the keyboards in the UF Classic series are equipped with velocity response and aftertouch.



**Velocity response** means when you play the keyboard, it will respond to the initial force used to strike the keys.  
**Aftertouch** means after you press and hold a key, it will continue to respond to additional pressure applied to the keys.

- 2 Pitchbend**  
It can change the pitch up and down, and when released it will automatically return to the center position.
- 3 Modulation**  
It will make the sound vibrant, and when released it will stay at that position.
- 4 SEQ Transport**  
They are used for sequence control or remote control.
- 5 NO Function**
- 6 Layer**  
This button will switch the function layers for faders and knobs, so you can control many things conveniently.
- 7 Knobs (KN1-8)**  
They are used to send continuous control change data.
- 8 Faders (CS1-9)**  
They are used to send continuous control change data.
- 9 Display**  
You will see all the information here.
- 10 Octave / Transpose**  
They are used to change the keyboard pitch either by an octave change or semitone.
- 11 Shift**  
It is used with other control parts for more functions.
- 12 Function Shortcut Buttons (F1-F6)**  
They are used for fast function select or to send user-defined parameters.
- 13 DATA Dial**  
Use it to change the value quickly.
- 14 Exit / Enter**  
Use them to confirm or cancel data changes, and use them for bank operation.

## 1.2 Rear Panel

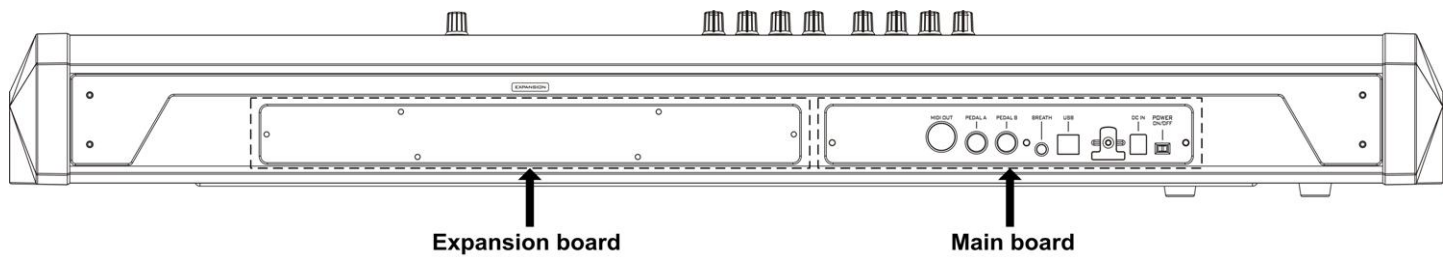

- The expansion board slot: it is used for an expansion board, such as a firewire expansion board or an sound module expansion board, etc.
- The mainboard terminals: All the connector ports and switches are located here.

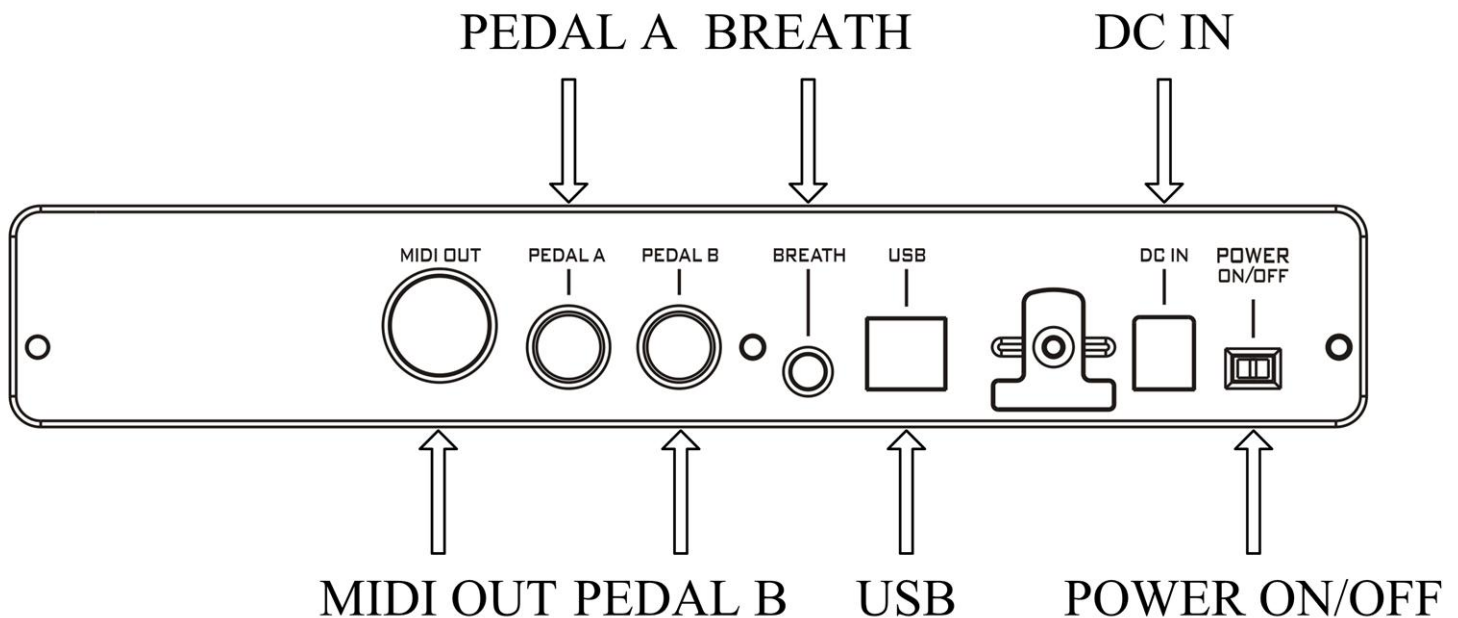

- MIDI OUT port ×1
- PEDAL A jack: 1/4" TRS ×1, can be used for volume or sustain pedal.
- PEDAL B jack: 1/4" TRS ×1, can be used for volume or sustain pedal.
- BREATH (Breath control or BC) jack: 1/8" TRS ×1, compatible with YAMAHA BC3.
- USB port: to make computer connection for MIDI data transfer and get the USB bus power
- DC IN(AC adaptor power in port): Connect the AC adaptor here
- POWER ON/OFF switch: Use it to turn the instrument on/off.

## 2 Installation Guide

### 2.1 Power Supply

1. Make sure the power switch is set to OFF.
2. Connect the AC adaptor to the POWER IN port in the rear panel.
3. Make sure the AC requirement of the AC adaptor is compliant with the local AC supply, then connect the AC adaptor to the power supply outlet.



Make sure the AC requirement of the AC adaptor is compliant with the local AC supply, otherwise it will cause severe damage to the AC adaptor or the instrument, and it may cause electrical shock!



Only the AC adaptor designed for this product should be used. If you cannot find the right adaptor or the adaptor does not work, please contact local CME dealers. The usage of an improper adaptor may cause fire or electrical shock!



The AC adaptor varies from country to country. If you take the product from one country to another, please make sure your AC adaptor compliant with the local power supply. If you are not sure about the technical information for the power supply or the adaptor, you can consult a qualified local electrical engineer.

### 2.2 Power On Order

When you have this product connected to a system, please set all the volumes to minimum then follow the proper order to turn all the devices on: master MIDI device (which sends out MIDI data), slave MIDI device (which receives MIDI data), audio devices (mixer, amplifier, speakers). When you follow this order, all the signals (MIDI and audio) will go properly from the beginning to the end. If you will turn off the system, please follow the reverse order (turn off the audio devices first, then the MIDI devices).

## 3 Connections



Before you make these connections, please turn off all devices to avoid possible damage.

Please refer to the fig. below to make connections:

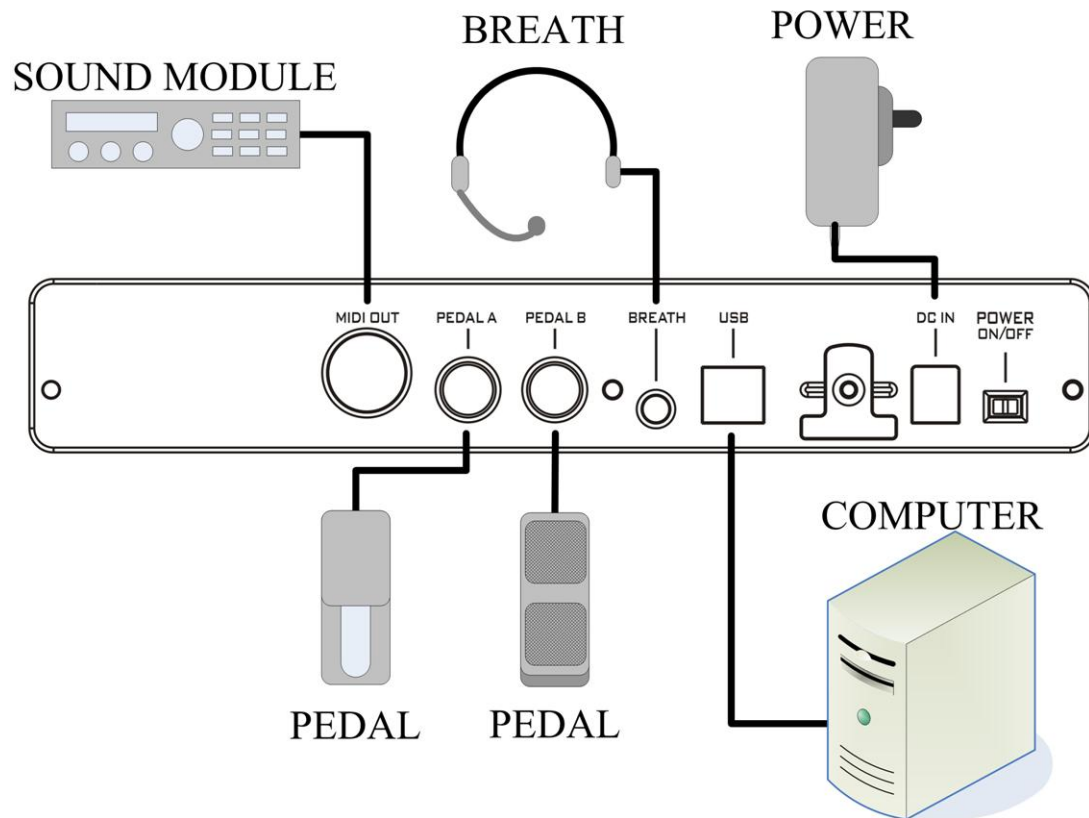

## 4 Basic Operation

The **【SHIFT】** button:

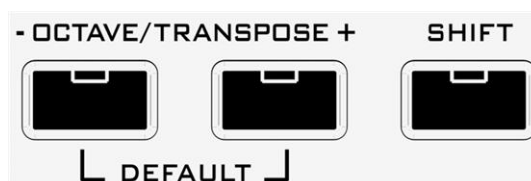

- Press and hold the **【SHIFT】** button then press the **【OCTAVE/TRANSPOSE】** button for the transpose function.
- Press the **【SHIFT】** button to make it light on, the keyboard is switched to the keyboard function mode.

**【Data dial】** and the **【EXIT/ENTER】** button:

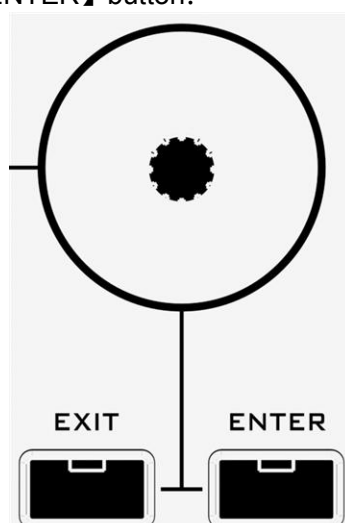

- By default the data dial is used to change the voice#. When you reach the desired voice#, press **【ENTER】** to send the MIDI data. You can also press **【EXIT】** to cancel the voice# change.
- In the keyboard function mode, you can also use **【Data dial】** and **【EXIT/ENTER】** to change the parameters.

**The [LAYER] button:**

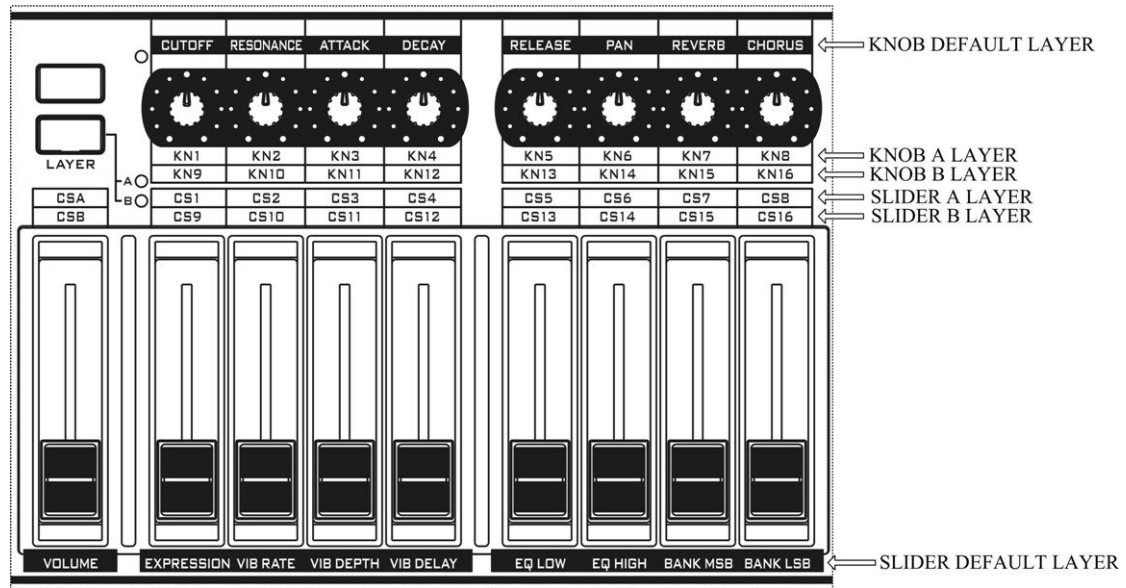

Use this button to switch to the function layers for knobs, faders and buttons. There are three layers for knobs, faders and buttons, and you can see the current layer from the right layer indicators: both indicator A and B off – the default layer; only indicator A on – layer A; only indicator B on – layer B.



# 5 Turning On

## 5.1 Turning On Normally

- Set the power switch on the rear panel to ON to turn on this product.

## 5.2 Driver Installation

- After you connect this product to your computer via USB and turn the product on, the computer will find it device and install the driver automatically.
- You can plug and play this product on WINDOWS XP or Mac OSX.
- When the driver installation is finished, this product will be recognized as the "USB Audio Device".
- The MIDI driver offers 2 USB INs and 2 USB OUTs.



Sometimes you may need to restart your computer during the driver installation. Please follow the on-screen instructions.

## 5.3 Turning On With Initalizaing

- If you press and hold both **【OCTAVE-】** and **【OCTAVE+】** buttons while turning on this product, it will enter the initialization process and return to the normal mode after the initializing is finished.



The initializing operation will clear all the user settings, please be careful !

# 6 Basic Functions

## 6.1 Selecting A Voice Quickly

- Rotate the data dial to find the voice# then press the **【ENTER】** button to send the MIDI data, or press the **【EXIT】** button to cancel the operation.



This operation will send the program change message to select the voice.



Voice# range in some sound modules is 0-127 instead of 1-128 in this product.

## 6.2 Transpose And Octave

- Octave shift
  - You can shift the keyboard pitch in octaves by using the Octave function.
  - When the octave is shifted, the related button indicator will be on.
  - The octave shift range is -03~00~03. Press the two octave buttons at the same time will set the octave shift to 00, and the indicator will be off.
- Transpose
  - You can shift the keyboard pitch in semi-notes by using the Transpose function.
  - When the transpose value is changed, the related button indicator will flash slowly.
  - The transpose range is -12~00~12 semi-notes. Press the two transpose buttons at the same time will set the transpose to 00, and the indicator will be off.
  - When both octave and transpose values are changed, the related buttons will flash quickly.
- The default keyboard ranges of UF 50/60/70/80 are listed below:

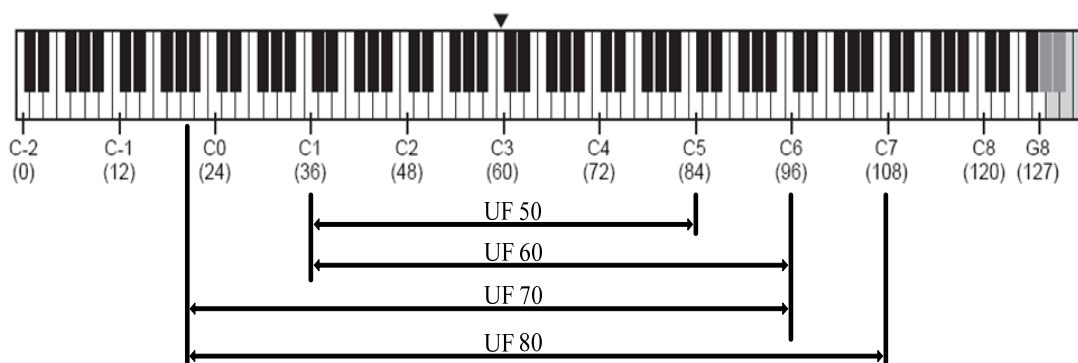

◆ The Pitch and key#(note#) list:

OCTAVE#	C	C#	D	D#	E	F	F#	G	G#	A	A#	B
-1	0	1	2	3	4	5	6	7	8	9	10	11
0	12	13	14	15	16	17	18	19	20	21	22	23
1	24	25	26	27	28	29	30	31	32	33	34	35
2	36	37	38	39	40	41	42	43	44	45	46	47
3	48	49	50	51	52	53	54	55	56	57	58	59
4	60	61	62	63	64	65	66	67	68	69	70	71
5	72	73	74	75	76	77	78	79	80	81	82	83
6	84	85	86	87	88	89	90	91	92	93	94	95
7	96	97	98	99	100	101	102	103	104	105	106	107
8	108	109	110	111	112	113	114	115	116	117	118	119
9	120	121	122	123	124	125	126	127				

## 6.3 Using Knobs And Faders

- When you adjust a knob or a fader, it will send specific MIDI data to change related parameter.
- When you adjust a knob or a fader, you will see related information on the DISPLAY.
- Please refer to the appendix <Initial status> for more information.



You can customize the MIDI data to be sent using the **【ASSIGN】**function (8.1).

## 6.4 Using SEQ Control Buttons

- Press the SEQ control buttons to send specific MIDI data.
- Please refer to the appendix <Initial status> for more information.



You can customize the MIDI data to be sent using the **【ASSIGN】**function (8.1).

## 6.5 Using Function Shortcut Buttons

- Press the function shortcut button F1~F6 to send specific MIDI data.
- Please refer to the appendix <Initial status> for more information.



You can customize the MIDI data to be sent using the **【ASSIGN】** function (8.1-8.3).

## 6.6 Pitch Wheel And Modulation Wheel

- Use the pitch wheel to send the pitch bend data by default, and the pitch bend range is up one semi-note and down one semi-note.
- Use the modulation wheel to send the modulation data.



You can customize the MIDI data to be sent using the **【ASSIGN】**function (8.1).

## 6.7 Pedal

- For the two pedal jacks, each one can be used for continuous pedal (e.g volume pedal) or switch pedal (e.g sustain pedal).
- By default, PEDAL A is for sustain pedal and send CC#64 message, the data value is either 0 or 127(switch data); PEDAL B is for volume pedal and send CC#11 message, the data range is 0-127(continuous data).
- To change pedal type or polarity, please use the system settings function (9.3-9.6).



You can customize the MIDI data to be sent using the **【ASSIGN】**function (8.1).

## 6.8 Breath Controller

- Use the breath control jack for a breath controller such as YAMAHA BC3 and send out the MIDI data.



You can customize the MIDI data to be sent using the **【ASSIGN】**function (8.1).



By turning the gain and fine tune knobs in the breath controller, you get a good breath feeling and data range.

## 6.9 Aftertouch

- After pressing a key, you can continue applying force to send channel after touch data.
- You can adjust the data sending rate or turn off those MIDI data (9.2).
- Please refer to the appendix <After touch curve list>.



You can customize the MIDI data to be sent using the **【ASSIGN】**function (8.1).

## 6.10 Bank Selection And Program Change (Patch)

### 6.10.1 Bank MSB Select

- Operation: **【SHIFT】** ⇒ **C1** **【Bank MSB Select】** ⇒ **【Set value】** ⇒ **【ENTER】**
- MIDI message sent: CC#0 + CC#32 + Program
- Default value: 0
- Value range: 0-127

### 6.10.2 Bank LSB Select

- Operation: **【SHIFT】** ⇒ **C#1** **【Bank LSB Select】** ⇒ **【Set value】** ⇒ **【ENTER】**
- MIDI message sent: CC#0 + CC#32 + Program
- Default value: 0
- Value range: 0-127

### 6.10.3 Program Change

- Operation: **【SHIFT】** ⇒ **D1** **【Program Change】** ⇒ **【Set value】** ⇒ **【ENTER】**
- MIDI message sent: CC#0 + CC#32 + Program
- Default value: 1
- Value range: 1-128



You can finish setting all the three values then press **【ENTER】** to send the data.

### 6.11 Keyboard Channel

- Operation: **【SHIFT】** ⇒ **A#1** **【Keyboard Channel】** ⇒ **【Set value】** ⇒ **【ENTER】**
- Default value: 1
- Value range: 1-16



The keyboard channel settings only affect the keyboard, pitch wheel, modulation wheel, BC and pedals. The channels of faders, knobs and buttons will not be changed. To set the channels of faders, knobs or buttons, please use the **【ASSIGN】** function (8.1).

# 7 Advanced Functions

## 7.1 Dual Mode

- When the dual mode is enabled, all the notes played will be sent to two MIDI channels, so the sound will be doubled.
- In the dual mode, Transpose, Octave, and keyboard channel will only work for the second MIDI channel. However, the pitch wheel, modulation wheel, BC and pedals work for both the two MIDI channels.
- Operation: 【SHIFT】 ⇒ B1 【Dual】 ⇒ 【ENTER】
- Default value: Off
- Value range: Off、On



The dual and split functions can not be used at the same time.

## 7.2 Split Mode

- When the split mode is enabled, the keyboard is divided to two regions (the left region and the right region). The two regions have independent settings such as MIDI channel, voice settings, transpose and octave. The original settings work for the left region.
- In the split mode, transpose and octave settings only work for the right region. However, the pitch wheel, modulation wheel, BC and pedals work for both the two regions.
- Operation: 【SHIFT】 ⇒ C2 【Split】 ⇒ 【Set value】 ⇒ 【ENTER】
- Default value: Off、54
- Value range: Off、36-84



The dual and split functions can not be used at the same time.

## 7.3 Scale

- The default scale type is 12 equal tones. However, you can change the scale type to meet your music style.
- Operation: 【SHIFT】 ⇒ G#1 【Scale】 ⇒ 【Set value】 ⇒ 【ENTER】
- Default value: 000
- Value range: 000-041
- Please refer to the appendix <scale list> for more information.



The Scale and Temperament functions can not be used at the same time.



If you set the scale other than the default one, the keyboard will be in mono mode.

## 7.4 Temperament

- You can change the temperament other than the default equal one.
- Operation: 【SHIFT】 ⇒ A1 【Temperament】 ⇒ 【Set value】 ⇒ 【ENTER】
- Default value: 000
- Value range: 000-012
- Please refer to the appendix <Temperament list> for more information.



The Scale and Temperament functions can not be used at the same time.



When the temperament function is enabled, the keyboard will be in mono mode.

## 7.5 Drawbar

- While playing a organ voice, you can use the Drawbar function to make the 9 faders work as the organ drawbars (data value will be sent reversely), so you can control the organ voice conveniently.
- Operation: 【SHIFT】 ⇒ F#1 【Drawbar】 ⇒ 【Set value】 ⇒ 【ENTER】
- Default value: Off
- Value range: Off、On

## 7.6 Tempo

- By using the TEMPO function, you can send the TEMPO change data to control the TEMPO of the external sequencer.
- Operation: 【SHIFT】 ⇒ G1 【Tempo】 ⇒ 【Set value】 ⇒ 【ENTER】
- Default value: Off
- Value range: Off, 30-250



If the external sequencer does not accept the Tempo change data, or it is not properly configured, the Tempo function will not work.

## 7.7 MIDI Reset Message

- You can reset the external MIDI device by sending a MIDI reset message.

Name	Key	MIDI message sent
Reset All Control	D3	CC#121
GM On	D#3	F0 7E 7F 09 01 F7
GM2 On	E3	F0 7E 7F 09 03 F7
GS On	F3	F0 41 10 42 12 40 00 7F 00 41 F7
XG On	F#3	F0 43 10 4C 00 00 7E 00 F7
CME On	G3	F0 00 20 63 00 00 00 00 7F F7



Please make sure your MIDI device support the related MIDI reset message before using this function.

# 8 Assigning

## 8.1 Assigning Controllers

- You can use the ASSIGN function to re-define a control parts by data type and MIDI channel.
- Operation: **【SHIFT】** ⇒ **D#1** **【Assign Controller】** ⇒ **【Locate a control part】** ⇒ **【Set value】** ⇒ **【ENTER】** ⇒ **【Assign Channel】** ⇒ **【Set value】** ⇒ **【ENTER】**
- In the above assigning operation, to **【Locate】** a control part, please move a control part. For example, you can move a fader or rotate a knob, etc.
- Controller value range: 0-170
- Channel value range: 1-16
- Please refer to the appendix <Assignable controller list> for more information.



In <Assignable controller list>, the types from cc#147 to cc#169 are switch controllers, so they can only be assigned to buttons.



To assign the keyboard aftertouch to another controller, please use the key function assigning as follows:  
**【SHIFT】** ⇒ **A#4** **【Assign A.Touch】** ⇒ **【Set value】** ⇒ **【ENTER】**

## 8.2 Assigning Notes

- You can assign the function shortcut button F1-F6 to note on/off message and set the MIDI channel.
- Operation: **【SHIFT】** ⇒ **E1** **【Assign Note】** ⇒ **【Locate a part】** ⇒ **【Set value】** ⇒ **【ENTER】** ⇒ **【Assign Channel】** ⇒ **【Set value】** ⇒ **【ENTER】**
- In the above operation, please press a button from F1-F6 to **【Locate a part】** .
- The note velocity is fixed to 127.
- Note value range: 0-127
- Channel value range: 1-16

## 8.3 Assigning Program Changes

- You can assign the function shortcut button F1-F6 to program change message and set the MIDI channel.
- Operation: **【SHIFT】** ⇒ **F1** **【Assign Program】** ⇒ **【Locate a part】** ⇒ **【Set value】** ⇒ **【ENTER】** ⇒ **【Assign Channel】** ⇒ **【Set value】** ⇒ **【ENTER】**
- In the above operation, please press a button from F1-F6 to **【Locate a part】** .
- Voice value range: 1-128
- Channel value range: 1-16



Refer to the appendix <Assignable controller list>, <Note list> and <GM voice list>.



# 9 System Settings

## 9.1 Keyboard V.Curve

- You can try different velocity curves to find your favorite one and get the best touch response for the voice being played.
- Please refer to the appendix <Velocity curve list> for more information.
- Operation: 【SHIFT】 ⇒ C#2 【Keyboard V.Curve】 ⇒ 【Set value】 ⇒ 【ENTER】
- Default value: 01
- Value range: 00-09

Curve#	Name	Description
00	Normal	Straight line
01	Soft 1	Down curve
02	Soft 2	Down curve
03	Hard 1	Up curve
04	Hard 2	Up curve
05	Expand	Down then up
06	Compress	Up then down
07	Fixup 1	Velocity value fixed at 64
08	Fixup 2	Velocity value fixed at 100
09	Fixup 3	Velocity value fixed at 127



User UF Brain software Adjust velocity curves, please enter adjust velocity curves mode:

【SHIFT】 ⇒ B4 【Adjust Velocity Curves】 ⇒ 【ENTER】

## 9.2 A.Touch V.Curve

- Press and hold a key then change the pressure to send aftertouch data. You can try different aftertouch types to find your favorite one.
- Please refer to the appendix <Aftertouch list> for more information.
- Operation: 【SHIFT】 ⇒ D2 【Keyboard V.Curve】 ⇒ 【Set value】 ⇒ 【ENTER】
- Default value: 01
- Value range: Off, 01-07

A.Touch Curve#	Name	Description
Off	None	Aftertouch disabled
01	Normal	Straight line
02	Soft 1	Down curve
03	Soft 2	Down curve
04	Hard 1	Up curve
05	Hard 2	Up curve
06	Expand	Down then up
07	Compress	Up then down

## 9.3 Pedal A Polarity

- You can set the pedal A polarity to make it work properly.
- Operation: 【SHIFT】 ⇒ D#2 【Pedal Polarity】 ⇒ 【Set value】 ⇒ 【ENTER】
- Default value: 1
- Value range: 1-2

## 9.4 Pedal A Type

- If you change pedal A type from switch to continuous or vice versa, please set the proper pedal type.
- Operation: 【SHIFT】 ⇒ E2 【Pedal Polarity】 ⇒ 【Set value】 ⇒ 【ENTER】
- Default value: 1(switch)
- Value range: 1-2

## 9.5 Pedal B Polarity

- You can set the pedal B polarity to make it work properly.
- Operation: 【SHIFT】 ⇒ F2 【Pedal Polarity】 ⇒ 【Set value】 ⇒ 【ENTER】
- Default value: 1
- Value range: 1-2

## 9.6 Pedal B Type

- If you change pedal B type from switch to continuous or vice versa, please set the proper pedal type.
- Operation: 【SHIFT】 ⇒ F#2 【Pedal Polarity】 ⇒ 【Set value】 ⇒ 【ENTER】
- Default value: 2(continuous)
- Value range: 1-2

## 9.7 Local On/Off

- The local control decides if the MIDI data will be sent to the expansion board.
- Please refer to the appendix <MIDI route>.
- Operation: 【SHIFT】 ⇒ G2 【Local On/Off】 ⇒ 【Set value】 ⇒ 【ENTER】
- Default value: On
- Value range: On, Off

## 9.8 Data Dump

- Use this function to dump the instrument settings by system exclusive messages, so you can quickly save and restore the settings.
- Operation: 【SHIFT】 ⇒ G#2 【Dump】 ⇒ 【ENTER】
- MIDI message sent: F0 00 20 63.....F7

# 10 Display

- You can choose the contents to display, so you will see the information you want.

## 10.1 Program Display

- To display the voice#:
- Operation: **【SHIFT】** ⇒ **A<sub>2</sub>** **【Program】** ⇒ **【ENTER】**
- Value range: 1-128

## 10.2 Bank MSB Display

- To display the bank MSB:
- Operation: **【SHIFT】** ⇒ **A<sub>#2</sub>** **【Bank MSB】** ⇒ **【ENTER】**
- Value range: 0-127

## 10.3 Bank LSB Display

- To display the bank LSB:
- Operation: **【SHIFT】** ⇒ **B<sub>2</sub>** **【Bank LSB】** ⇒ **【ENTER】**
- Value range: 0-127

## 10.4 Note Display

- To display the note#:
- Operation: **【SHIFT】** ⇒ **C<sub>3</sub>** **【Note】**
- Value range: 0-127

## 10.5 Controller Display

- To display the cc#:
- Operation: **【SHIFT】** ⇒ **C<sub>#3</sub>** **【Controller】**
- Value range: 0-127



By default, the cc# is displayed.

# 11 U-CTRL mode

## Notes for the U-CTRL mode:

- You can control popular computer software in the U-CTRL mode. In this mode, knobs, faders and buttons will send out preset control data.
- U-CTRL mode 1 is compatible with the Macike Control mode, suitable to such software as Cubase, Nuendo, etc.
- U-CTRL mode 2 is compatible with the Mackie Hui mode, suitable to such software as Pro Tools, etc.
- Operation:
  - **【SHIFT】 ⇒ B3 【U-CTRL】 ⇒ 【Set value】 ⇒ 【ENTER】**
- Default: Off
- Range: Off, 1-2
- Follow the below steps to use U-CTRL
  - Enter the U-CTRL mode 1 or mode 2, and the LED around the data dial will light in “U” shape.
  - Launch the software to control, and load the Mackie Control or Mackie Hui template as per the software manual.
  - Set the remote control port to “USB AUDIO DEVICE [2]” in the software.
- Please refer to the list below for part function mapping:

UF parts	Mackie Control function	Mackie Hui function
SLIDER 1-8	SLIDER 1-8	SLIDER 1-8
SLIDER 0	SLIDER 0	-
JOG WHEEL	JOG WHEEL	JOG WHEEL
F1	BANK LEFT	BANK LEFT
F2	BANK RIGHT	BANK RIGHT
F3	CHANNEL LEFT	CHANNEL LEFT
F4	CHANNEL RIGHT	CHANNEL RIGHT
F5	PREVIOUS	ZOOM
F6	NEXT	SCRUB
SHIFT+F1	F1	EDIT
SHIFT+F2	F2	MIX
SHIFT+F3	F3	TRANSPORT
SHIFT+F4	F4	MEM LOC
SHIFT+F5	F5	ALT VIEW
SHIFT+F6	F6	CUT
EXIT	READ	READ
ENTER	WRITE	WRITE
SHIFT+EXIT	LEFT	LEFT
SHIFT+ENTER	RIGHT	RIGHT
REW	REWIND	REWIND
FF	FAST FWD	FAST FWD
STOP	STOP	STOP
PLAY	PLAY	PLAY
REC	RECORD	RECORD
RTZ	RTZ	-

## 12 Registration Bank Access

- You can save all the instrument settings to the registration BANK.
- There are about 10 registration BANKs in the instrument. If you need to save more registrations, you can use the data dump function to save the registration data to your computer (9.8).
- Saving the settings to a registration BANK:
  - Press the **【LOAD】** button and the **【SAVE】** button at the same time, and the BANK# will flash.
  - Use the data dial to locate the needed BANK#, then press the **【SAVE】** button to save.
- Loading the settings from a registration BANK:
  - Press the **【LOAD】** button and the **【SAVE】** button at the same time, and the BANK# will flash.
  - Use the data dial to locate the needed BANK#, then press the **【LOAD】** button to load.



The loaded data will override the current settings without notification. If the current settings are not saved, after the loading operation the original settings will be lost.

## 13 Firmware Update

### About the UPDATE function:

- With the UF Brain program, you can update the program and data of the instrument via USB connection. To get the newest UF Brain program, please visit [www.cme-pro.com](http://www.cme-pro.com)

## 14 Expansion

- You can use the expansion slot to connect an expansion board, such as a firewire expansion board, a sound module expansion board, etc.
- Please read the expansion board user's manual carefully and follow the instructions to install and use the expansion board.
- Please visit [www.cme-pro.com](http://www.cme-pro.com) for more information.

# 15 Appendix

## 15.1 Initial Status

Status	Contral part	Panel text	Function
all layers	Pitch wheel	PITCHBEND	Pitchbend
all layers	Modulation	MODULATION	CC#1-Modulation
all layers	Pedal A	SUSTAIN	CC#64-Sustain
all layers	Pedal B	CONTROLLER	CC#11-Expression
all layers	Breath control	BREATH	CC#2-Breath
all layers	Return to zero	(RTZ)	CC#115
all layers	Rewind	(REW)	CC#116
all layers	Fast forward	(FF)	CC#117
all layers	Record	(REC)	CC#114
all layers	Stop	(STOP)	CC#118
all layers	Play	(PLAY)	CC#119
all layers	Locate 1	LOCATE1	CC#112
all layers	Locate 2	LOCATE2	CC#113
all layers	Button F1+F2	MUTE	MUTE
all layers	Button F2+F3	SNAPSHOT	SNAPSHOT
all layers	Button F4+F5	GM ON	GM ON
all layers	Button F5+F6	ALL NOTES OFF	CC#123
default layer (indicator A+B off)	Knob 1	CUTOFF	CC#74-CUTOFF
default layer (indicator A+B off)	Knob 2	RESONANCE	CC#71-RESONANCE
default layer (indicator A+B off)	Knob 3	ATTACK	CC#73-ATTACK
default layer (indicator A+B off)	Knob 4	DECAY	CC#75-DECAY
default layer (indicator A+B off)	Knob 5	RELEASE	CC#72-RELEASE
default layer (indicator A+B off)	Knob 6	PAN	CC#10-PAN
default layer (indicator A+B off)	Knob 7	REVERB	CC#91-REVERB
default layer (indicator A+B off)	Knob 8	CHORUS	CC#93-CHORUS
default layer (indicator A+B off)	Fader 1	VOLUME	CC#07-VOLUME
default layer (indicator A+B off)	Fader 2	EXPRESSION	CC#11-EXPRESSION
default layer (indicator A+B off)	Fader 3	VIB RATE	CC#76-VIB RATE
default layer (indicator A+B off)	Fader 4	VIB DEPTH	CC#77-VIB DEPTH
default layer (indicator A+B off)	Fader 5	VIB DELAY	CC#78-VIB DELAY
default layer (indicator A+B off)	Fader 6	EQ LOW	EQ Low
default layer (indicator A+B off)	Fader 7	EQ HIGH	EQ High
default layer (indicator A+B off)	Fader 8	BANK MSB	CC#00-BANK MSB
default layer (indicator A+B off)	Fader 9	BANK LSB	CC#32-BANK LSB
default layer (indicator A+B off)	Button F1	F1	Program#01
default layer (indicator A+B off)	Button F2	F2	Program#06
default layer (indicator A+B off)	Button F3	F3	Program#17
default layer (indicator A+B off)	Button F4	F4	Program#26
default layer (indicator A+B off)	Button F5	F5	Program#49
default layer (indicator A+B off)	Button F6	F6	Program#62
Layer A (indicator A on)	Knob 1	KN1	CC#10-PAN,CH1
Layer A (indicator A on)	Knob 2	KN2	CC#10-PAN,CH2

Layer A (indicator A on)	Knob 3	KN3	CC#10-PAN,CH3
Layer A (indicator A on)	Knob 4	KN4	CC#10-PAN,CH4
Layer A (indicator A on)	Knob 5	KN5	CC#10-PAN,CH5
Layer A (indicator A on)	Knob 6	KN6	CC#10-PAN,CH6
Layer A (indicator A on)	Knob 7	KN7	CC#10-PAN,CH7
Layer A (indicator A on)	Knob 8	KN8	CC#10-PAN,CH8
Layer A (indicator A on)	Fader 1	CSa	MASTER VOLUME
Layer A (indicator A on)	Fader 2	CS1	CC#07-VOLUME,CH1
Layer A (indicator A on)	Fader 3	CS2	CC#07-VOLUME,CH2
Layer A (indicator A on)	Fader 4	CS3	CC#07-VOLUME,CH3
Layer A (indicator A on)	Fader 5	CS4	CC#07-VOLUME,CH4
Layer A (indicator A on)	Fader 6	CS5	CC#07-VOLUME,CH5
Layer A (indicator A on)	Fader 7	CS6	CC#07-VOLUME,CH6
Layer A (indicator A on)	Fader 8	CS7	CC#07-VOLUME,CH7
Layer A (indicator A on)	Fader 9	CS8	CC#07-VOLUME,CH8
Layer A (indicator A on)	Button F1	F1	CC#50
Layer A (indicator A on)	Button F2	F2	CC#51
Layer A (indicator A on)	Button F3	F3	CC#52
Layer A (indicator A on)	Button F4	F4	CC#53
Layer A (indicator A on)	Button F5	F5	CC#54
Layer A (indicator A on)	Button F6	F6	CC#55
Layer B (indicator B on)	Knob 1	KN1	CC#10-PAN,CH9
Layer B (indicator B on)	Knob 2	KN2	CC#10-PAN,CH10
Layer B (indicator B on)	Knob 3	KN3	CC#10-PAN,CH11
Layer B (indicator B on)	Knob 4	KN4	CC#10-PAN,CH12
Layer B (indicator B on)	Knob 5	KN5	CC#10-PAN,CH13
Layer B (indicator B on)	Knob 6	KN6	CC#10-PAN,CH14
Layer B (indicator B on)	Knob 7	KN7	CC#10-PAN,CH15
Layer B (indicator B on)	Knob 8	KN8	CC#10-PAN,CH16
Layer B (indicator B on)	Fader 1	CSb	MASTER VOLUME
Layer B (indicator B on)	Fader 2	CS9	CC#07-VOLUME,CH9
Layer B (indicator B on)	Fader 3	CS10	CC#07-VOLUME,CH10
Layer B (indicator B on)	Fader 4	CS11	CC#07-VOLUME,CH11
Layer B (indicator B on)	Fader 5	CS12	CC#07-VOLUME,CH12
Layer B (indicator B on)	Fader 6	CS13	CC#07-VOLUME,CH13
Layer B (indicator B on)	Fader 7	CS14	CC#07-VOLUME,CH14
Layer B (indicator B on)	Fader 8	CS15	CC#07-VOLUME,CH15
Layer B (indicator B on)	Fader 9	CS16	CC#07-VOLUME,CH16
Layer B (indicator B on)	Button F1	F1	CC#56
Layer B (indicator B on)	Button F2	F2	CC#57
Layer B (indicator B on)	Button F3	F3	CC#58
Layer B (indicator B on)	Button F4	F4	CC#59
Layer B (indicator B on)	Button F5	F5	CC#60
Layer B (indicator B on)	Button F6	F6	CC#61

## 15.2 Assignable Controllers List

Controller#	Name
000	Bank Select
001	Modulation wheel
002	Breath control
003	Undefined
004	Foot controller
005	Portamento time
006	Data Entry
007	Channel Volume
008	Balance
009	Undefined
010	Pan
011	Expression
012	Effect control 1
013	Effect control 2
014	Undefined
015	Undefined
016	General Purpose #1
017	General Purpose #2
018	General Purpose #3
019	General Purpose #4
020	Undefined
021	Undefined
022	Undefined
023	Undefined
024	Undefined
025	Undefined
026	Undefined
027	Undefined
028	Undefined
029	Undefined
030	Undefined
031	Undefined
032	Bank Select
033	Modulation wheel
034	Breath control
035	Undefined
036	Foot controller
037	Portamento time
038	Data entry
039	Channel Volume
040	Balance
041	Undefined
042	Pan



043	Expression
044	Effect control 1
045	Effect control 2
046	Undefined
047	Undefined
048	General Purpose #1
049	General Purpose #2
050	General Purpose #3
051	General Purpose #4
052	Undefined
053	Undefined
054	Undefined
055	Undefined
056	Undefined
057	Undefined
058	Undefined
059	Undefined
060	Undefined
061	Undefined
062	Undefined
063	Undefined
064	Damper pedal
065	Portamento on/off
066	Sostenuto on/off
067	Soft pedal on/off
068	Legato Footswitch
069	Hold 2
070	Sound Variation
071	Timbre/Harmonic Intens.
072	Release Time
073	Attack Time
074	Brightness
075	Decay Time
076	Vibrato Rate)
077	Vibrato Depth
078	Vibrato Delay
079	Sound Cont.
080	General Purpose #5
081	General Purpose #6
082	General Purpose #7
083	General Purpose #8
084	Portamento Control
085	Undefined
086	Undefined
087	Undefined
088	Undefined

089	Undefined
090	Undefined
091	Reverb Send Level
092	Tremolo Depth
093	Chorus Send Level
094	Celeste/Detune Depth
095	Phaser Depth
096	Data entry +1
097	Data entry -1
098	NRPN LSB
099	NRPN MSB
100	RPN LSB
101	RPN MSB
102	Undefined
103	Undefined
104	Undefined
105	Undefined
106	Undefined
107	Undefined
108	Undefined
109	Undefined
110	Undefined
111	Undefined
112	Undefined
113	Undefined
114	Undefined
115	Undefined
116	Undefined
117	Undefined
118	Undefined
119	Undefined
120	All Sound Off
121	Reset All Controllers
122	Local control on/off
123	All notes off
124	Omni mode off
125	Omni mode on
126	Poly mode off
127	Poly mode on
128 *	Pitch Bend Sensitivity
129 *	Fine Tuning
130 *	Coarse Tuning
131 *	Vibrato Rate
132 *	Vibrato Depth
133 *	Vibrato Delay

134 *	Low Pass Filter Cutoff Frequency
135 *	Low Pass Filter Resonance
136 *	High Pass Filter Cutoff Frequency
137 *	EQ Low Gain
138 *	EQ High Gain
139 *	EQ Low Frequency
140 *	EQ High Frequency
141 *	EG Attack Time
142 *	EG Decay Time
143 *	EG Release Time
144 *	Channel Pressure
145 *	Master Volume
146 *	Master Balance
147 **	CME ON
148 **	GM ON
149 **	XG ON
150 **	GS ON
151 **	GM2 ON
152 *	Tempo
153 **	Start
154 **	Continue
155 **	Stop
156 **	System Reset
157 **	Stop
158 **	PLAY
159 **	DEFERRED PLAY
160 **	FORWARD
161 **	REWIND
162 **	RECORD STROBE
163 **	RECORD EXIT
164 **	RECORD PAUSE
165 **	PAUSE
166 **	EJECT
167 **	CHASE
168 **	COMMAND ERROR RESET
169 **	MMC RESET
170 *	Pitch Bend

\* Those controllers cannot be assigned to buttons, Seq or sustain pedal.

\*\* Those controllers cannot be assigned to pitch wheel, modulation wheel, aftertouch, breath control, faders or knobs.

## 15.3 GM Voice List

Voice#	Name	Voice#	Name	Voice#	Name	Voice#	Name
001	GrandPno	033	Aco.Bass	065	SprnoSax	097	Rain
002	BritePno	034	FngrBass	066	Alto Sax	098	SoundTrk
003	El.Grand	035	PickBass	067	TenorSax	099	Crystal
004	HnkyTonk	036	Fretless	068	Bari.Sax	100	Atmosphr
005	E.Piano1	037	SlapBas1	069	Oboe	101	Bright
006	E.Piano2	038	SlapBas2	070	Eng.Horn	102	Goblins
007	Harpsi.	039	SynBass1	071	Bassoon	103	Echoes
008	Clavi	040	SynBass2	072	Clarinet	104	Sci-Fi
009	Celesta	041	Violin	073	Piccolo	105	Sitar
010	Glocken	042	Viola	074	Flute	106	Banjo
011	MusicBox	043	Cello	075	Recorder	107	Shamisen
012	Vibes	044	Contrabs	076	PanFlute	108	Koto
013	Marimba	045	Trem.Str	077	Bottle	109	Kalimba
014	Xylophon	046	Pizz.Str	078	Shakhchi	110	Bagpipe
015	TubulBel	047	Harp	079	Whistle	111	Fiddle
016	Dulcimer	048	Timpani	080	Ocarina	112	Shanai
017	DrawOrgn	049	Strings1	081	SquareLd	113	TnklBell
018	PercOrgn	050	Strings2	082	Saw Lead	114	Agogo
019	RockOrgn	051	Syn Str1	083	CaliopLd	115	SteelDrm
020	ChrchOrg	052	Syn Str2	084	Chiff Ld	116	WoodBlok
021	ReedOrgn	053	ChiorAah	085	CharanLd	117	TaikoDrm
022	Acordion	054	VoiceOoh	086	Voice Ld	118	MelodTom
023	Harmnica	055	SynVoice	087	Fifth Ld	119	Syn Drum
024	TangoAcd	056	Orch.Hit	088	Bass&Ld	120	RevCymbI
025	NylonGtr	057	Trumpet	089	NewAgePad	121	FretNoiz
026	SteelGtr	058	Trombone	090	Warm Pad	122	BrthNoiz
027	Jazz Gtr	059	Tuba	091	PolySyPd	123	Seashore
028	CleanGtr	060	Mute Trp	092	ChoirPad	124	Tweet
029	Mute.Gtr	061	Fr. Horn	093	BowedPad	125	Telephone
030	Ovrdrive	062	BrasSect	094	MetalPad	126	Helicptr
031	Dist.Gtr	063	SynBrss1	095	Halo Pad	127	Applause
032	GtrHarmo	064	SynBrss2	096	SweepPad	128	Gunshot

## 15.4 Scale List

Scale No.	Pitch name	C	C#	D	D#	E	F	F#	G	G#	A	A#	B
	Note number:	1	2	3	4	5	6	7	8	9	10	11	12
001	Major Scale	C	C	D	D	E	F	F	G	G	A	A	B
002	Pentatonic Major Scale	C	C	D	D	E	E	E	G	G	A	A	A
003	Blues Major Scale	C	C	D#	D#	F	F	F#	G	G	A	A	A
004	Minor Scale	C	C	D	D#	D#	F	F	G	G#	G#	A#	A#
005	Melodic Minor Scale	C	C	D	D#	D#	F	F	G	G	A	A	B
006	Harmonic Minor Scale	C	C	D	D#	D#	F	F	G	G#	A	A	B
007	Pentatonic Minor Scale	C	C	D#	D#	D#	F	F	G	G	A#	A#	A#
008	Blues Minor Scale	C	C	D#	D#	D#	F	F#	G	G	A#	A#	A#
009	Augmented Scale	C	C	D#	D#	E	E	G	G	G#	G#	B	B
010	Be-Bop Scale	C	C	D	D	E	F	F	G	G	A	A#	B
011	Whole-Half Scale	C	C	D	D#	D#	F	F#	F#	G#	A	A	B
012	Half-Whole Scale	C	C#	C#	D#	E	E	F#	G	G	A	A#	A#
013	Whole Tone Scale	C	C	D	D	E	E	F#	F#	G#	G#	A#	A#
014	Augmented fifth Scale	C	C	D	D	E	F	F	G	G#	A	A	B
015	Algerian Scale	C	C	D	D#	D#	F#	F#	G	G#	G#	B	B
016	Arabian Scale	C	C	D	D	E	F	F#	F#	G#	G#	A#	A#
017	Balinese Scale	C	C#	C#	D#	D#	D#	G	G	G#	G#	G#	G#
018	Bartok Scale	C	C	D	D	E	E	F#	G	G	A	A#	A#
019	Byzantine Scale	C	C#	C#	E	E	F	F	G	G#	G#	B	B
020	Egyptian Scale	C	C	D	D	F	F	F	G	G	G	A#	A#
021	Enigmatic Scale	C	C#	C#	E	E	E	F#	F#	G#	G#	A#	B
022	Spanish Scale	C	C#	C#	E	E	F	F	G	G#	G#	A#	A#
023	Spanish 8 Tone Scale	C	C#	C#	D#	E	F	F#	F#	G#	G#	A#	A#
024	Gypsy Scale	C	C#	C#	E	E	F	F	G	G	A	A#	A#
025	Hungarian Gypsy Scale	C	C	D	D#	D#	F#	F#	G	G#	G#	A#	A#
026	Hindu Scale	C	C	D	D	E	F	F	G	G#	G#	A#	A#
027	Iwato Scale	C	C#	C#	C#	F	F	F#	F#	F#	A#	A#	A#
028	Japanese Scale	C	C#	C#	C#	F	F	F	G	G#	G#	G#	G#
029	Javanese Scale	C	C#	C#	D#	D#	F	F	G	G	A	A#	A#
030	Hawaiian Scale	C	C	D	D#	D#	F	F	G	G	A	A	B
031	Hirajoshi Scale	C	C	D	D#	D#	D#	G	G	G#	G#	G#	G#
032	Hungarian Minor Scale	C	C	D	D#	D#	F#	F#	G	G#	G#	B	B
033	Hungarian Major Scale	C	C	D#	D#	E	E	F#	G	G	A	A#	A#
034	Leading Whole Tone Scale	C	C	D	D	E	E	F#	F#	G#	G#	A#	B
035	Mohammedan Scale	C	C	D	D#	D#	F	F	G	G#	G#	B	B
036	Mongolian Scale	C	C	D	D	E	E	G	G	G	A#	A#	A#
037	Neapolitan Minor Scale	C	C#	C#	D#	D#	F	F	G	G#	G#	B	B
038	Neapolitan Major Scale	C	C#	C#	D#	D#	F	F	G	G	A	A	B
039	Oriental Scale	C	C#	C#	E	E	F	F#	F#	A	A	A#	A#
040	Pelog Scale	C	C#	C#	D#	D#	D#	G	G	G	A#	A#	A#
041	Persian Scale	C	C#	C#	E	E	F	F#	F#	G#	G#	B	B

001-Major Scale



002-Pentatonic Major Scale

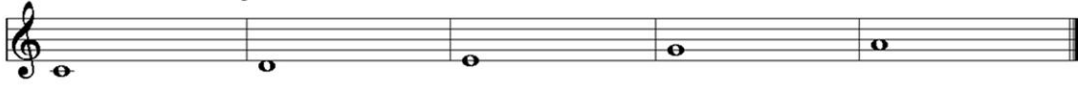

003-Blues Major Scale



004-Minor Scale

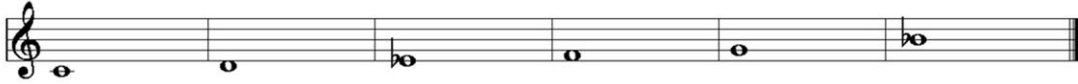

005-Melodic Minor Scale

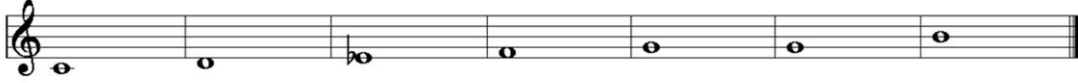

006-Harmonic Minor Scale

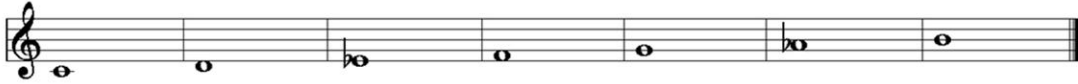

007-Pentatonic Minor Scale

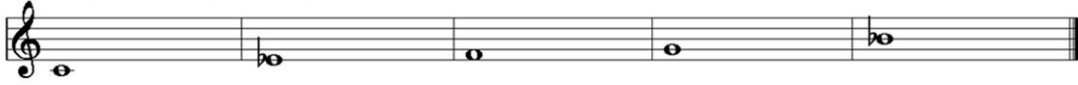

008-Blues Minor Scale

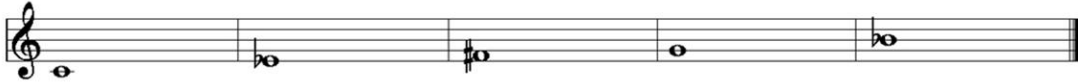

009-Augmented Scale



010-Be-Bop Scale



011-Whole-Half Scale



012-Half-Whole Scale



013-Whole Tone Scale



014-Augmented fifth Scale



015-Algerian Scale

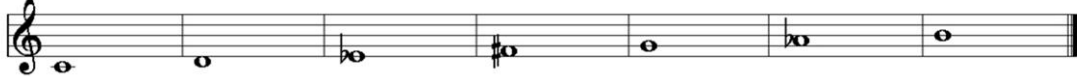

016-Arabian Scale

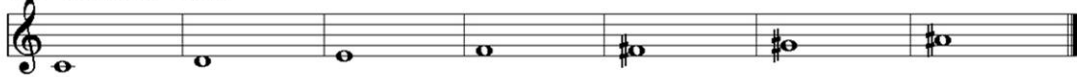

017-Balinese Scale

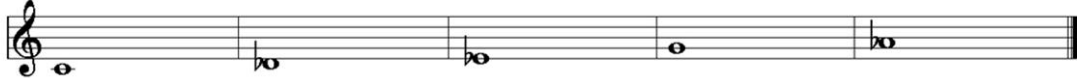

018-Bartok Scale

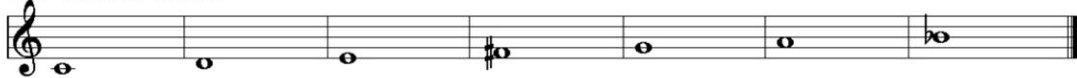

019-Byzantine Scale

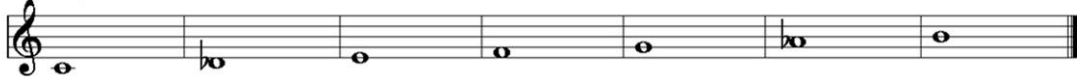

020-Egyptian Scale

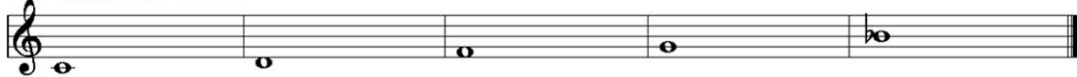

021-Enigmatic Scale

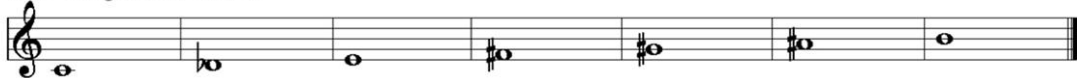

022-Spanish Scale

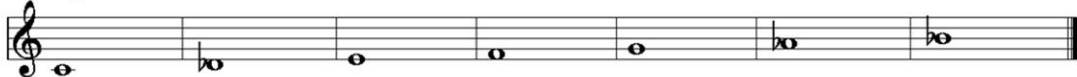

023-Spanish 8 Tone Scale

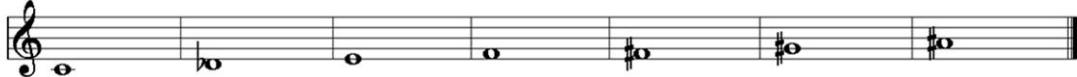

024-Gypsy Scale

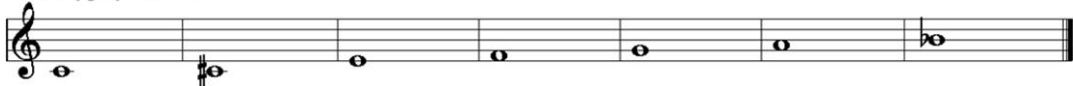

025-Hungarian Gypsy Scale



026-Hindu Scale

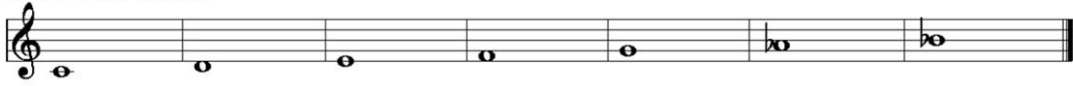

027-Iwato Scale

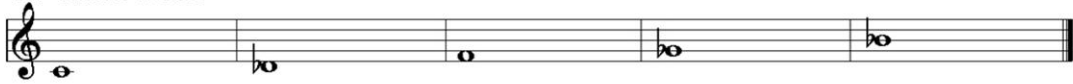

028-Japanese Scale

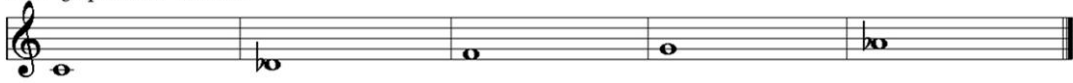

029-Javanese Scale

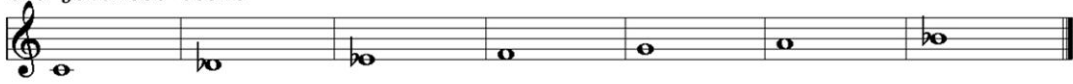

030-Hawaiian Scale

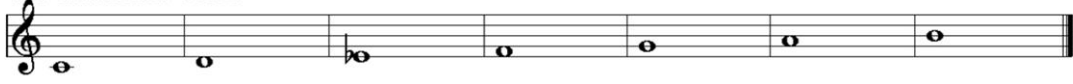

031-Hirajoshi Scale

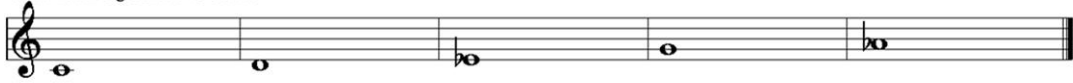

032-Hungarian Minor Scale



033-Hungarian Major Scale



034-Leading Whole Tone Scale

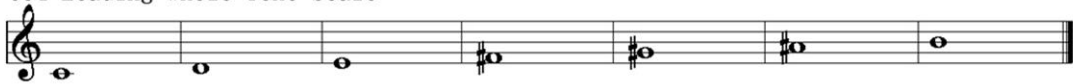

035-Mohammedan Scale

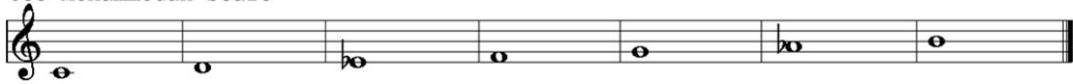



036-Mongolian Scale



037-Neapolitan Minor Scale



038-Neapolitan Major Scale

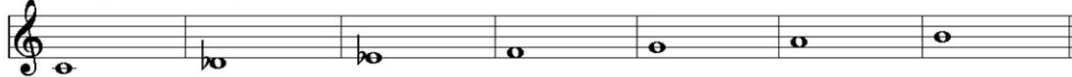

039-Oriental Scale

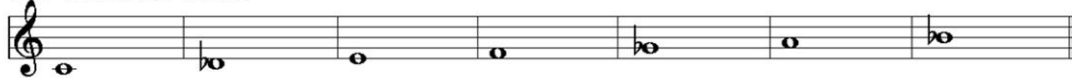

040-Pelog Scale



041-Persian Scale

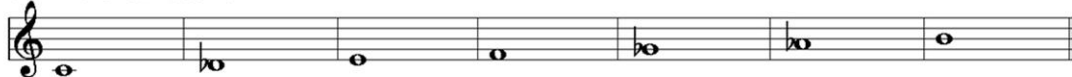

## 15.5 Note List

Note #	Name
000	C-2
001	C#-2
002	D-2
003	D#-2
004	E-2
005	F-2
006	F#-2
007	G-2
008	G#-2
009	A-2
010	A#-2
011	B-2
012	C-1
013	C#-1
014	D-1
015	D#-1
016	E-1
017	F-1
018	F#-1
019	G-1
020	G#-1
021	A-1
022	A#-1
023	B-1
024	C0
025	C#0
026	D0
027	D#0
028	E0
029	F0
030	F#0
031	G0

Note #	Name
032	G#0
033	A0
034	A#0
035	B0
036	C1
037	C#1
038	D1
039	D#1
040	E1
041	F1
042	F#1
043	G1
044	G#1
045	A1
046	A#1
047	B1
048	C2
049	C#2
050	D2
051	D#2
052	E2
053	F2
054	F#2
055	G2
056	G#2
057	A2
058	A#2
059	B2
060	C3
061	C#3
062	D3
063	D#3

Note #	Name
064	E3
065	F3
066	F#3
067	G3
068	G#3
069	A3
070	A#3
071	B3
072	C4
073	C#4
074	D4
075	D#4
076	E4
077	F4
078	F#4
079	G4
080	G#4
081	A4
082	A#4
083	B4
084	C5
085	C#5
086	D5
087	D#5
088	E5
089	F5
090	F#5
091	G5
092	G#5
093	A5
094	A#5
095	B5

Note #	Name
096	C6
097	C#6
098	D6
099	D#6
100	E6
101	F6
102	F#6
103	G6
104	G#6
105	A6
106	A#6
107	B6
108	C7
109	C#7
110	D7
111	D#7
112	E7
113	F7
114	F#7
115	G7
116	G#7
117	A7
118	A#7
119	B7
120	C8
121	C#8
122	D8
123	D#8
124	E8
125	F8
126	F#8
127	G8

## 15.6 Temperament List

No.	Type	C	C#	D	D#	E	F	F#	G	G#	A	A#	B
0	EQUAL	△	△	△	△	△	△	△	△	△	△	△	△
1	ARABIC	△	△	△	△	▲	△	△	△	△	△	△	▲
2	ARABIC	△	▲	△	△	△	△	△	△	△	△	△	△
3	ARABIC	△	△	△	△	△	△	▲	△	△	△	△	▲
4	ARABIC	△	▲	△	△	△	△	▲	△	△	△	△	△
5	ARABIC	△	△	▲	△	△	△	△	▲	△	△	△	△
6	ARABIC	△	△	▲	△	△	△	△	△	▲	△	△	△
7	ARABIC	△	△	△	▲	△	△	△	△	▲	△	△	△
8	ARABIC	△	▲	△	△	△	△	△	△	▲	△	△	△
9	ARABIC	△	▲	△	△	△	△	△	△	△	▲	△	△
10	ARABIC	△	△	△	△	▲	△	△	△	△	△	△	△
11	ARABIC	△	△	△	△	△	△	△	△	△	▲	△	△
12	ARABIC	△	△	△	△	△	△	△	△	△	△	△	▲

Note: △=Normal pitch, ▲=Changed pitch

## 15.7 Velocity Curve List

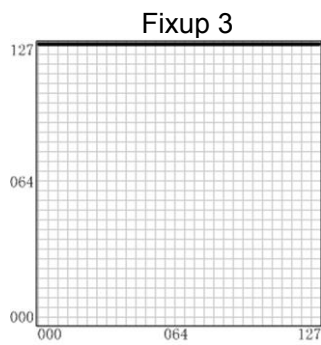
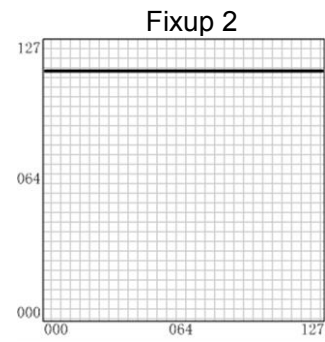
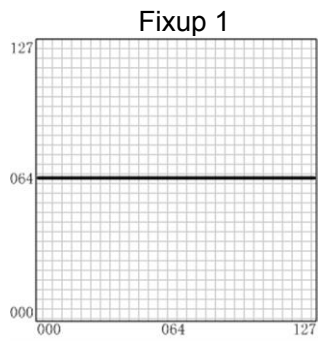
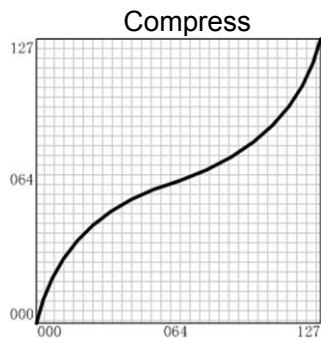
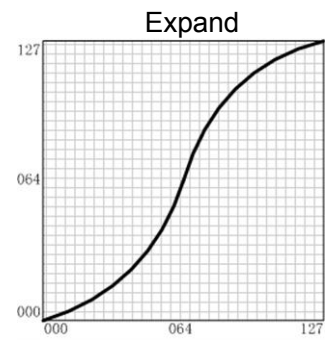
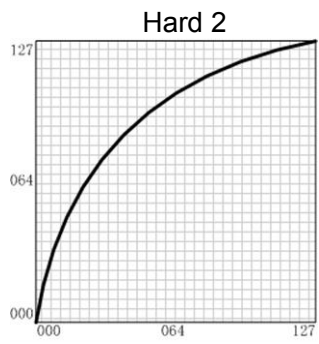
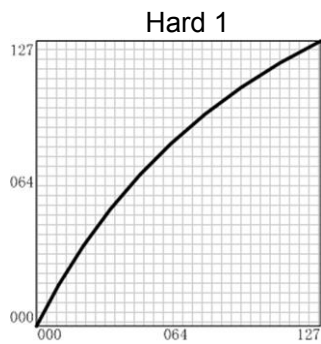
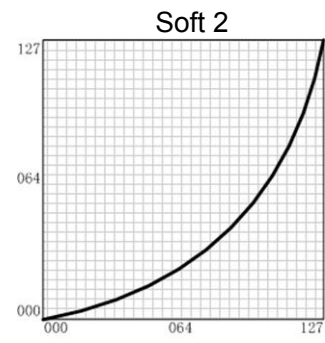
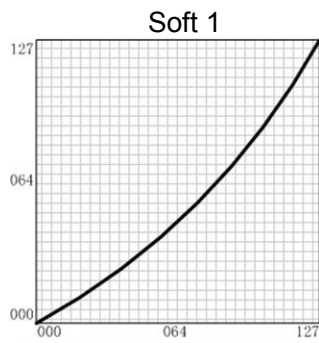
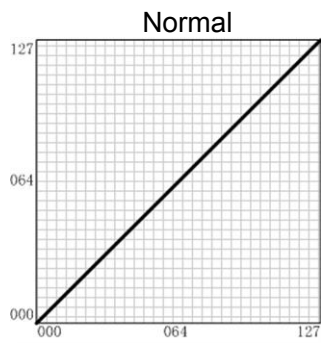

## 15.8 Aftertouch Curve List

Off

Normal

Soft 1

None

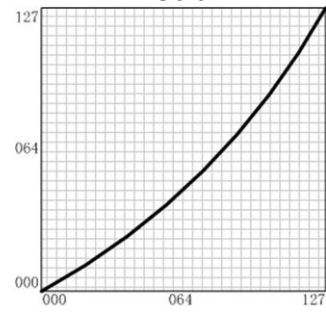
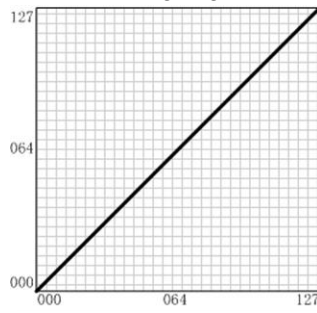

Soft 2

Hard 1

Hard 2

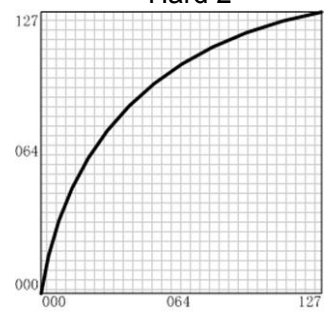
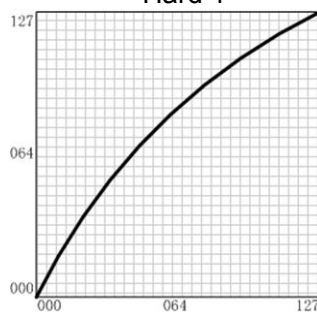
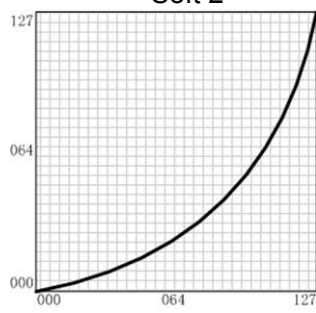

Expand

Compress

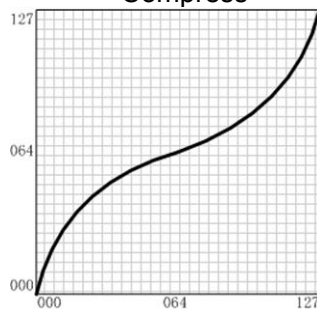
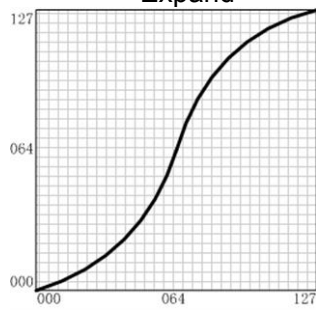

# 15.9 MIDI Route

**MIDI route in the normal mode**

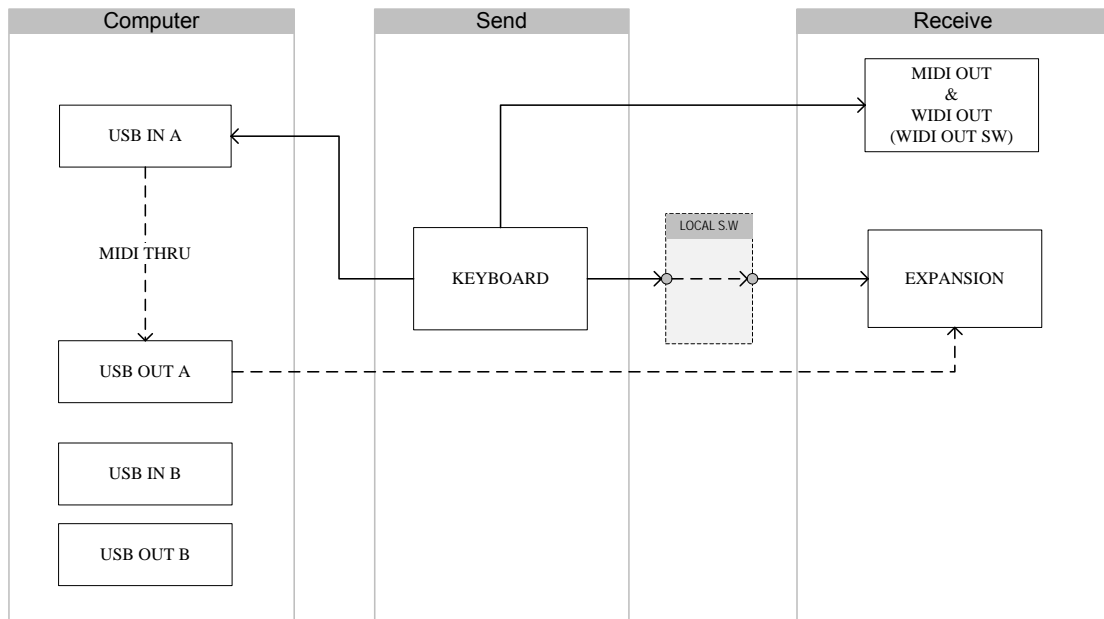

**MIDI route in the U-CTRL mode**

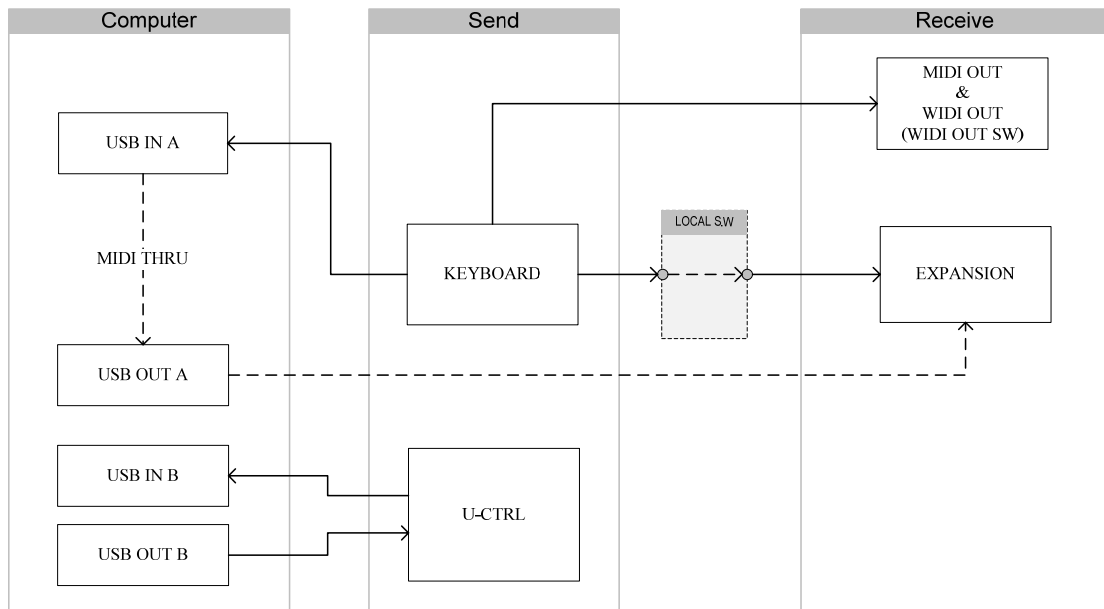

# 16 Troubleshooting

## Trouble with possible reasons and solution

- After turning on the power switch, the instrument is not powered on:
  1. Make sure the USB connection is made and the computer is on.
  2. Make sure the power connector is firmly connected to the power outlet.
  3. Check the power connections.
- No sound when playing the instrument
  1. Check the volume settings of the tone generator and speaker system
  2. Check the MIDI connection and the audio cable
  3. Check Master and Channel Volume faders
  4. Check Channel Expression Knobs
  5. Check the attack time of the filter
  6. Make sure you have the right settings in you music software
  7. Check the MIDI route settings
  8. Check the Controller Pedal position
- Continuous long sound:
  1. Check Sustain pedal (Damper pedal)
  2. Check the release time of the filter
  3. Use All notes off or Reset
- Improper voice
  1. Tone generator not set properly, please Initialize or Reset..
  2. Improper MIDI routing, please check connections and settings.
- Wrong pitch
  1. Check the transpose or octave settings.
  2. MIDI pitch is tuned.
  3. Pitch bend message not returned to default, please reset.
  4. Check the scale or temperament settings.
- Tempo knob does not work

Make sure your sequencer software supports this function with the right settings (Refer to the Sync section of your software manual)
- Some functions do not work
  1. Check the parts assigning.
  2. It is possible that your tone generator or music software does not support those functions
- You hear two sounds when playing one key:

Disable the dual function.
- Cannot select voice

Read the data list of your tone generator for voice select detail, and properly set the tone BANK MSB and LSB

# 17 Specifications

- Keyboard
  - ◇ UF50 Classic: 49 keys(C1 - C5), (velocity sensitive and aftertouch)
  - ◇ UF60 Classic: 61 keys(C1 - C6), (velocity sensitive and aftertouch)
  - ◇ UF70 Classic: 76 keys(A-1 - C6), (velocity sensitive and aftertouch)
  - ◇ UF80 Classic: 88 keys(A-1 - C7), (Professional Hammer Action Keyboard, velocity sensitive and aftertouch)
- Functions
  - ◇ Basic functions: USB MIDI, Octave shift, Transpose, Pitch bend wheel, Modulation wheel, Pedals, Breath control, MIDI OUT, Faders, Knobs
  - ◇ MIDI Data: Sequence control, MIDI clock, bank select, Program change, GM System On, GS System on, XG System On, Control change, All Notes Off, etc.
  - ◇ Parameters: Transpose, Octave, MIDI out channels, Velocity curve, Pitch bend, Breath control, Modulation, Brightness, Aftertouch, Aftertouch curve, etc.
- Panel Controls and Indicators
  - ◇ Function shortcut buttons with light × 6
  - ◇ Potentiometer knobs x 8, Faders × 9
  - ◇ Data dial x 1, Switch button with light × 1, Exit/Enter button × 2
  - ◇ Seq transport buttons × 6, (two with light)
  - ◇ Octave/Transpose buttons with light × 2
- Display
  - ◇ 3 digs, 7-segment LED display
- Input/Output Terminals
  - ◇ POWER ON/OFF switch × 1
  - ◇ POWER IN connector × 1
  - ◇ USB port × 1
  - ◇ PEDAL jack × 2
  - ◇ BREATH Control jack × 1
  - ◇ MIDI OUT port × 1
- Power Supply
  - ◇ USB bus power or AC Power Adaptor
  - ◇ AC Power Adaptor requirement: 12V 1.5A DC
  - ◇ 
- Dimensions (W×D×H) and Weight:
  - ◇ UF 50 Classic: 859 × 348 × 113 mm, 8.2 kg
  - ◇ UF 60 Classic: 1022 × 348 × 113 mm, 9.8 kg
  - ◇ UF 70 Classic: 1232 × 348 × 113 mm, 11.8 kg
  - ◇ UF 80 Classic: 1408 × 372 × 150 mm, 23.5 kg

\* Specifications and appearance are subject to change without notice.

---

# 18 MIDI Implementation Chart

Model: UF 50/60/70/80 Classic **MIDI Implementation chart**

Ver: 1.0

Function		Transmitted	Recognized
Basic Channel	Default Changed	1 1~16	×
Mode	Default Messages Altered	×	×
Note Number:	True voice	0~127 *****	×
Velocity	Note ON Note OFF	○ v=0~127 ○ v=0~127	×
Aftertouch	Key's Ch's	×	×
Pitch Bend		○	×
Control Change		0~127	×
Prog Change:	True #	○ *****	×
System Exclusive		○	○
System Real Time	Clock Commands	○ ○	×
System Command	Song position	×	×
Aux Messages	Active Sense	×	×

○: Yes      ×: No

- CME is continually improving its products, and every attempt is made to ensure the information in the user's manual is current and accurate. However, CME will not be responsible for possible discrepancies between the manual and the real product.





2010 - 05

(Version 3.0)

**Central Music Co.**

Tel: +86-10-8580 1115

Fax: +86-10-8580 1114

Web: [www.cme-pro.com](http://www.cme-pro.com)

E-mail for support: [support@cme-pro.com](mailto:support@cme-pro.com)